



WEE Technology Company Limited

General Purpose Rectifiers

S5A THRU S5M

VOLTAGE RANGE 50 to 1000 Volts
CURRENT 5.0 Ampere

FEATURES

- Plastic package has underwrites laboratory flammability Classification 94V-0
- For surface mounted applications
- Low profile package
- Built-in strain relief, ideal for automated placement
- Glass Passivated chip junction
- High temperature soldering:
250°C/10 second at terminals

MECHANICAL DATA

- Case: JEDED DO-214AA molded plastic over glass passivated chip
- Terminals: Solder plated, Solderable per MIL-STD-750, method 2026
- Polarity: Color band denotes cathode end
- Weight: 0.007ounce, 0.25 gram

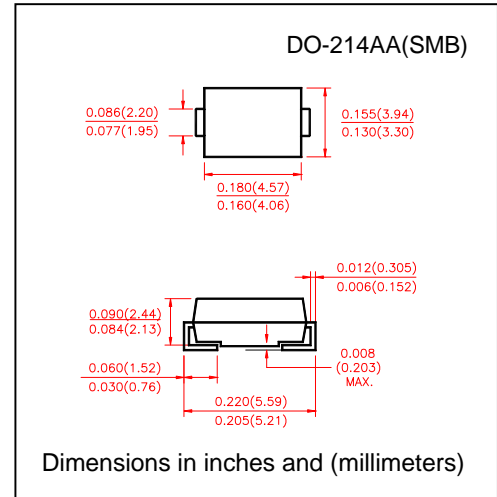

MAXIMUM RATINGS AND ELECTRICAL CHARACTERISTICS

- Ratings at 25°C ambient temperature unless otherwise specified

TYPE NUMBER	SYMBOLS	S5A	S5B	S5D	S5G	S5J	S5K	S5M	UNIT
Maximum Repetitive Peak Reverse Voltage	V_{RRM}	50	100	200	400	600	800	1000	Volts
Maximum RMS Voltage	V_{RMS}	35	70	140	280	420	560	700	Volts
Maximum DC Blocking Voltage	V_{DC}	50	100	200	400	600	800	1000	Volts
Maximum Average Forward Rectified Current at $T_L=100^\circ\text{C}$ (NOTE 3)	$I_{(AV)}$	5.0							Amps
Peak Forward Surge Current 8.3ms single half sine wave superimposed on rated load (JEDEC method)	I_{FSM}	150							Amps
Maximum Instantaneous Forward Voltage at 5.0A	V_F	1.15							Volts
Maximum DC Reverse Current at rated DC Blocking Voltage	$T_A = 25^\circ\text{C}$	10.0							μA
	$T_A = 125^\circ\text{C}$	250							
Typical junction capacitance (NOTE 1)	C_J	60							pF
Typical Thermal Resistance (NOTE 2)	$R_{\theta JL}$	47							$^\circ\text{C}/\text{W}$
	$R_{\theta JA}$	13							
Operating Junction and Storage Temperature Range	T_J, T_{STG}	-55 to +150							$^\circ\text{C}$

Notes:

1. Measured at 1.0MHz and applied reverse voltage of 4.0 Volts
2. Thermal resistance from Junction to ambient and from junction to lead mounted on P.C.B.with 0.3×0.3" (8.0 × 8.0mm) copper pad areas.



WEET Technology Company Limited

General Purpose Rectifiers

S5A THRU S5M

VOLTAGE RANGE 50 to 1000 Volts
CURRENT 5.0 Ampere

RATINGS AND CHARACTERISTIC CURVES S5A THRU S5M

FIG.1-FORWARD CURRENT DERATING CURVE

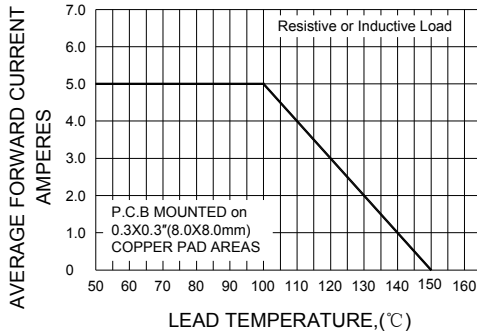

FIG.2-MAXIMUM NON-REPETITIVE PEAK FORWARD SURGE CURRENT

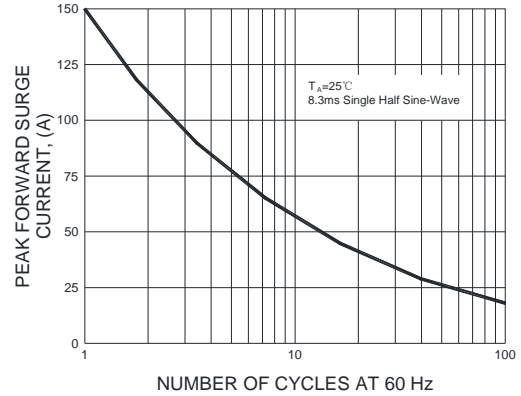

FIG.3-TYPICAL INSTANTANEOUS FORWARD CHARACTERISTICS

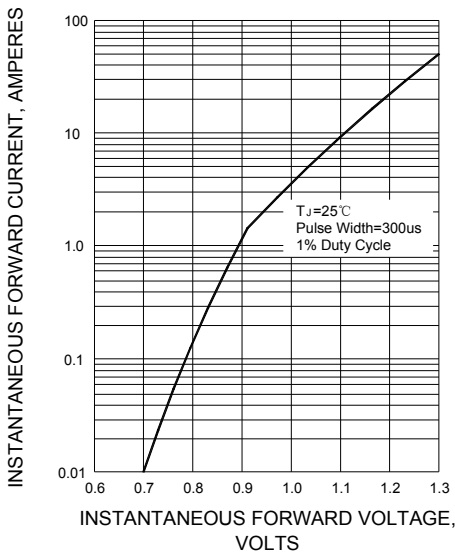

FIG.4-TYPICAL REVERSE CHARACTERISTICS

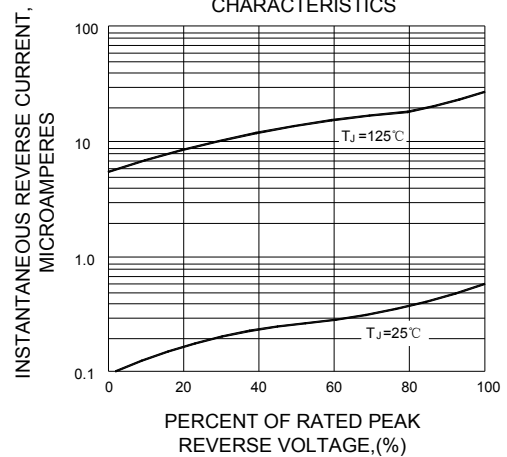

FIG.5-TYPICAL JUNCTION CAPACITANCE

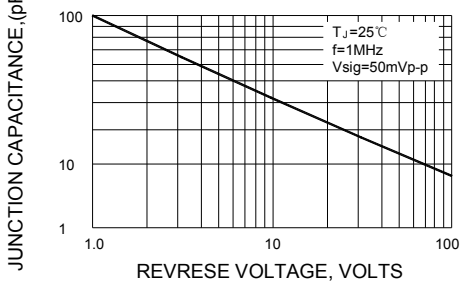
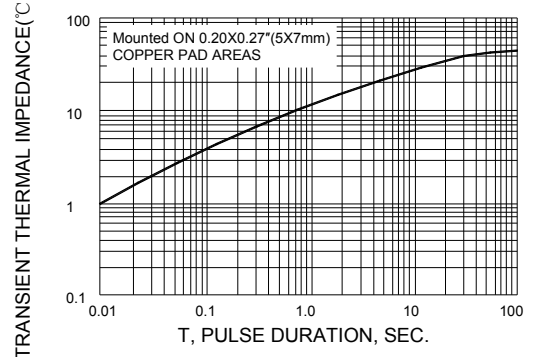

FIG.6-TYPICAL TRANSIENT THERMAL IMPEDANCE



Note: Specifications are subject to change without notice. For more detail and update, please visit our website.